

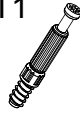





<p>K30</p> <p>16</p>	<p>T1</p> <p>16</p>	<p>M1</p> <p>16</p>	<p>ZP</p> <p>2</p>	<p>PZ</p> <p>2</p>	<p>F2</p> <p>12</p>	<p>S2</p> <p>1</p>	<p>S3</p> <p>1</p>
<p>S1</p> <p>1</p>	<p>W3,5x16</p> <p>2</p>	<p>W4x16</p> <p>4</p>	<p>Z1</p> <p>16</p>	<p>H120</p> <p>4</p>	<p>ODB</p> <p>1</p>		

T1	PZ	W3,5x16	ODB
			
16	2	2	1

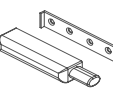
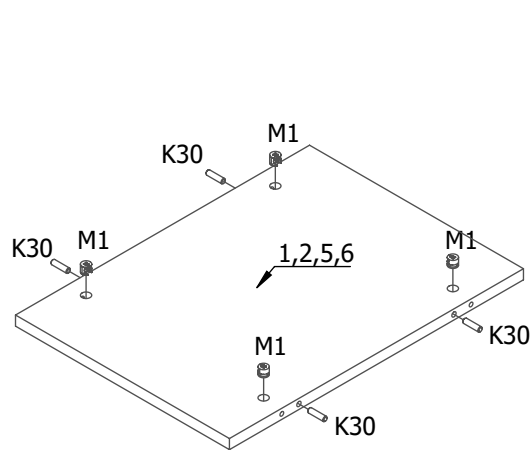
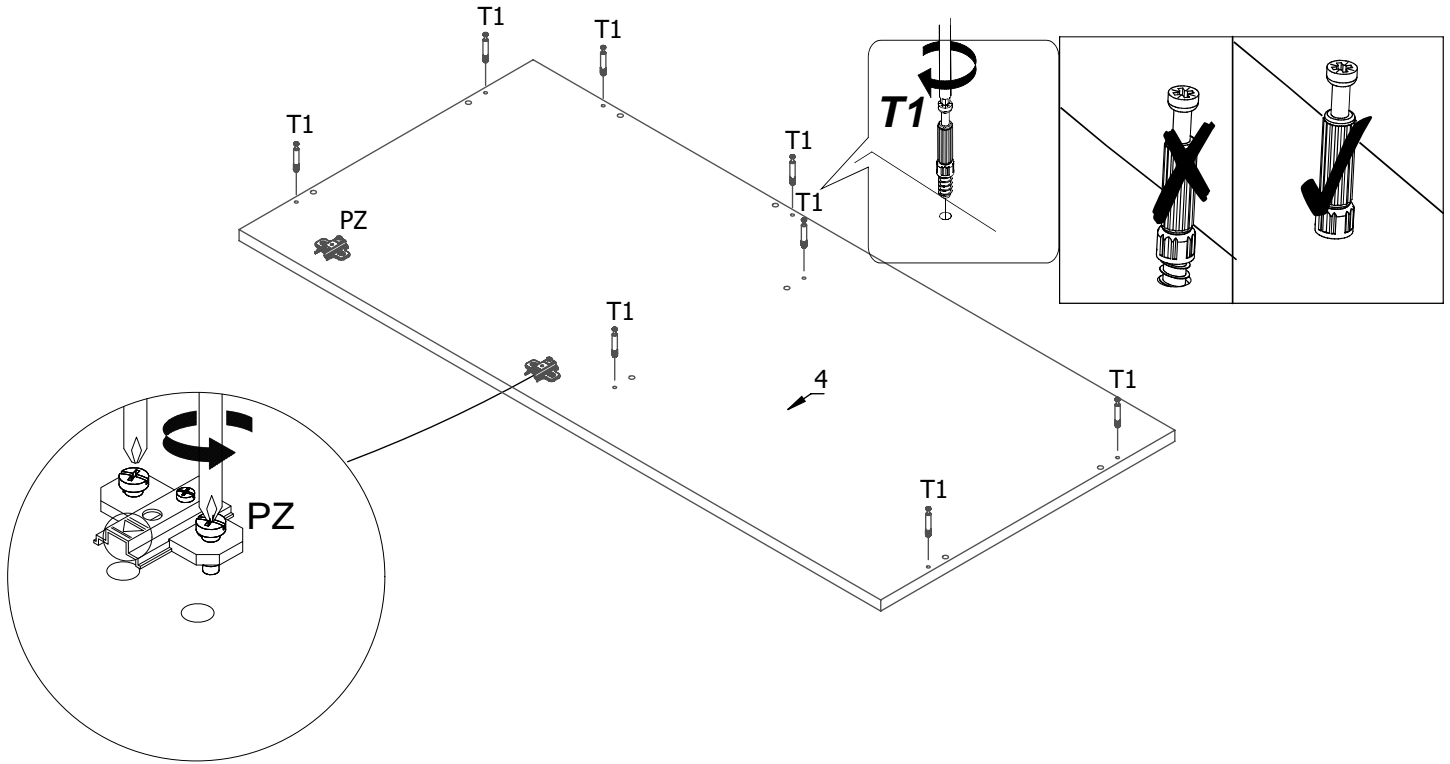
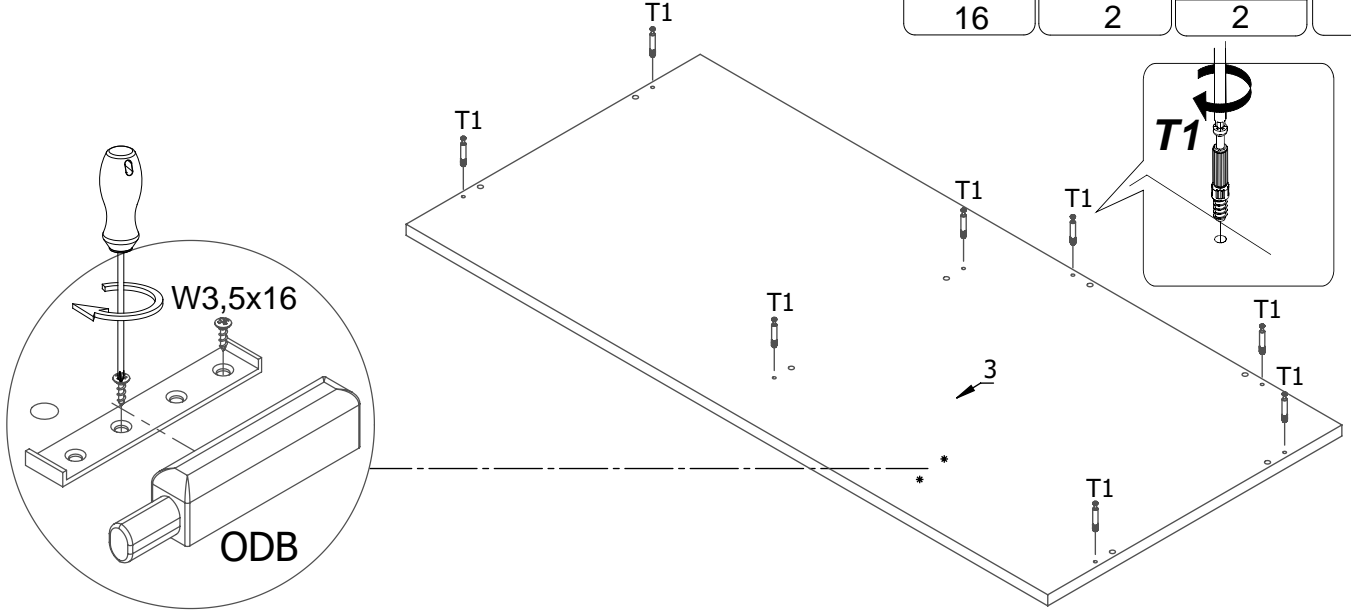

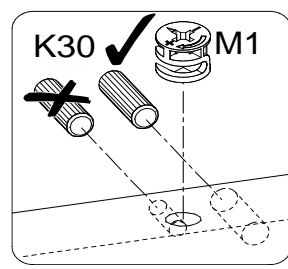
M1	K30
	
16	16

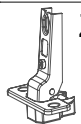

W4x16	ZP
	
4	2

